

# PRODUCT SHEET

## Description:

Sliding Door SISO-110CW,3000mm,AL,Ceiling/Wall, W/Self-Close & Soft Close,Alu  
Anodized,10-14mm Glass Thickness,Max 110KG,, Double Soft Pro Brake

## Item number:

28.29.621-0

Units	Box	Carton	HS Code	Barcode
Set	1	1	8302415000	
5704866487764				

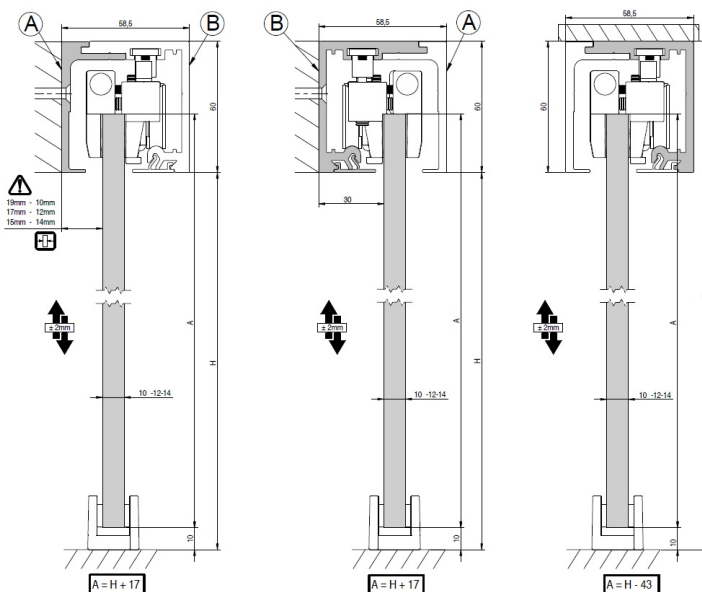
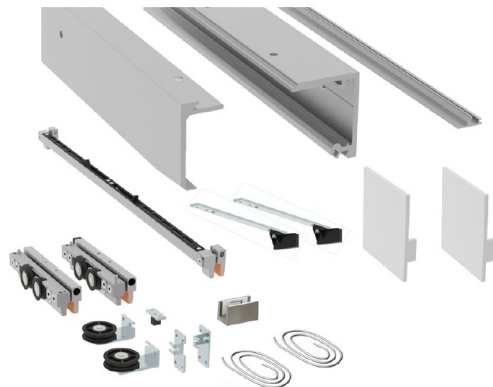

## SISO A/S

Mileparken 11  
DK-2740 Skovlunde  
Denmark  
VAT: DK 24786013

Phone +45 45 830 900

[www.siso.dk](http://www.siso.dk)  
[siso@siso.dk](mailto:siso@siso.dk)

Danske Bank  
Nytorv Branch  
Copenhagen  
SWIFT: DABADKKK

Account no.  
4180 3112 112936  
IBAN Account  
DK7230003112112936